

[404_{v5}] Shower System



DO NOT USE SOLVENT BASED NEOPRENE ADHESIVE

1 - WARRANTY	page 119
2 - PRINCIPLE	page 119
2.1 - Definition	
2.2 - Floor/wall coverings	
2.3 - Products	
3 - SUBSTRATES	page 119
4 - CONSTRUCTIONAL MEASURES	page 120
5 - FLOOR DRAIN	page 121
5.1 - Floor drains available from GERFLOR	
5.2 - Others recommended models	
5.3 - On timber substrate	
6 - PREPARING CORNERS	page 122
7 - INSTALLING THE FLOOR COVERING	page 122
7.1 - Substrate	
7.2 - Installation method	
7.3 - Installing the floor covering	
7.4 - Watertight sealing at edges	
7.5 - Treatment of joints	
7.6 - Shower / bedroom join	
8 - INSTALLING THE WALL COVERING	page 126
8.1 - Substrate	
8.2 - Preparing the wall	
8.3 - Installing the wall covering	
8.4 - Overlap	
8.5 - Wall-hung WC	
8.6 - Finishing - Connections	
9 - APPENDIX - SHOWER SYSTEM COMFORT PLUS	page 129
10 - LIST OF SPECIAL TOOLS	page 129
11 - ACCESSORIES	page 130

[404_{v5}] Shower System

All floor and wall coverings should be examined prior to installation for any problems of a visual nature. If there are any visible defects, please notify GERFLOR and do not begin installation without its agreement.

1. WARRANTY

1.1. PRODUCT WARRANTY

Floor and wall coverings must be installed in accordance with the Technical Notice, the Specification current on the contract signature date and with accepted best practice. In this case, the floor and wall coverings will be covered by the manufacturer's warranty.

1.2. TRAINING AND SUPPORT

The company GERFLOR:

- Offers specific training sessions on installation of Shower floor and wall coverings with the award of individual certificates
- Is able to intervene at the request of the enterprise responsible for the work
- Is able to assist the enterprise responsible for the work at the start of the project if requested.

2. PRINCIPLE

2.1. DEFINITION

Complete shower system based on PVC floor and wall coverings including use of floor drains and creation of slopes.

2.2. FLOOR/WALL COVERINGS

Flexible reinforced vinyl floor coverings in rolls certified as follows:

Commercial name	Classification	Thickness	Fire rating
TARASAFE ULTRA H2O	34/43	2 to 2.2 mm	C _{fl} -s1
TARASAFE DESIGN / ULTRA / STANDARD	34/43		B _{fl} -s1 (equivalent to M3 on M0 substrate)
TARASAFE H ₂ O	34/43		

Flexible reinforced vinyl wall covering in rolls:

Commercial name	Thickness	Fire rating
MURAL CALYPSO	0.9 mm	B-s2, d0 on M1 substrate

2.3. PRODUCTS

- Floor drains
 - Cove formers
 - Adhesives
 - Weld rods
 - Capping strip
 - Sealing products
 - Tarafoam 20 foam for the Comfort version of the shower system
- All surfaces (floors and walls up to the ceiling) will be treated with this complete system.**

3. SUBSTRATES

BARE SUBSTRATES FOR FLOOR COVERINGS

SUBSTRATE TYPE	STANDARDS
Slab laid directly on ground	Applicable local standards
Solid slab floors of cast in-situ concrete, continuous at supports	NF P 18 201, applicable local standards
Solid slab floors made of prefabricated pre-slabs and concrete cast in-situ, continuous at supports	CSTB specification 3221 May 2000 NF P 18 201, applicable local standards
Floors made of reinforced concrete hollow core slabs, with a topping layer continuous at supports	NF P 18 201, applicable local standards
Floors made of prestressed concrete hollow core slabs, with a topping layer continuous at supports	CSTB specification 2892 June 1996, applicable local standards
Ribbed floors with prefabricated beams combined with cast concrete or combined with other prefabricated components and concrete cast in-situ, continuous at supports	CSTB specification 2920 November 1996, applicable local standards
Floors of concrete cast in-situ on wide metal strips acting compositely, continuous at supports	Respective Technical Notices supplemented by addenda supplemented by common addendum no. 3 / 94 - 258, applicable local standards
Conventional hydraulic binder-based screeds or slabs	NF P 14 201, applicable local standards
Cement-based liquid screeds	Respective Technical Notices, applicable local standards
Floors of wood-based panels in EB+ private premises only	NF P 63 203, applicable local standards

[404_{v5}] Shower System

WALLS

PERMISSIBLE WALL SUBSTRATES BASED ON EXPOSURE TO WATER

SUBSTRATE	Concrete		Cement-based coating	Gypsum-based coating		Partition wall or wall lining		Partition wall with gypsum blocks			Ceramic tiled partition wall		Masonry of cellular concrete blocks	
	S1	S2	S3	S4	S5	S6	S7	S8	S9	S10	S11	S12	S13	S14
PREMISES														
EB + private	(1)		(3)			(8)					(4)	(5)	(6)	(6)
EB + collective	(2)	(2)	(3)									(5)	(6)	(6)
EC	(2)(7)	(2)(7)	(3)(7)									(5)(7)	(6)(7)	(6)(7)

DESCRIPTION AND REQUIREMENTS

- (1) coated with a type S5 smooth-finish coating or gypsum- or cement-based smooth-finish levelling compound
 (2) coated with a smooth-finish coating or cement-based smooth-finish levelling compound
 (3) denibbed and/or coated with a smooth-finish cement-based levelling compound (as per applicable local standards)
 Substrate not permitted
 (4) S11 with gypsum-based finish hardness > 60
 (5) S12 coated with a smooth-finish cement-based special coating (as per applicable local standards) described in the Technical Notice for the substrate
 (6) coated with a smooth-finish cement-based special coating for cellular concrete (as per applicable local standards)
 (7) EC premises: installation of TARASAFE PLUS only
 (8) S6: These substrates are only permitted in renovation work and in the case of existing painted panels, subject to carrying out suitable preparation after prior survey.

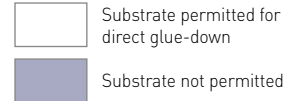

• Wall substrates:

- S 1 - NFP 18.210-1 (applicable local standards) regular poured concrete walls
- S 2 - NFP 10.210-1 (applicable local standards) refined surface poured concrete walls
- S 3 - NFP 15.201-1 (applicable local standards) mortar coatings
- S 4 - NFP 12.301 plaster for interior coatings hardness > 40
- S 5 - NFP 71.201 (applicable local standards) plaster for interior coatings hardness > 60
- S 6 - NFP 72.302 plasterboard panels

• Classification:

- EA premises: Dry premises
 EB premises: Moderately damp rooms (WC, etc.)
 EB+private premises (on slab and cement or wood based floors): Shower enclosure, private bathroom
 EB+collective premises (on slab and cement based floors):

- NFP 72.203 -1-(applicable local standards)
- NFP 72.204 -1-(applicable local standards)
- S 7 - water-repellent plasterboard panels
- S 8 - NFP 72.301 gypsum blocks
- S 9 - water-repellent gypsum blocks
- S10 - extra water-repellent gypsum blocks
- S11 - ceramic tiles (gypsum-based adhesive binder)
- S12 - ceramic tiles (cement-based adhesive binder)
- S13 - NFP 14.306 - Cellular concrete blocks
- S14 - Partition wall of cellular concrete panels

Individual shower for collective use in premises of the type: residential school, collective changing room, collective washing facilities not commercial in character, washing facilities accessible to the public.
 EC premises: Very damp premises (collective showers, sports changing rooms).

4. CONSTRUCTIONAL MEASURES

Special constructional measures must be taken and complied with to ensure correct installation and water tightness of the SHOWER SYSTEM employing a coving system solution.

4.1. ABOUT SUBSTRATES

FLOOR substrate with slope to drain (1%).

- Splash protection
- Right-angled, well finished wall-floor angle
- There must be no expansion joints crossing the area concerned
- Substrates (walls / partitions)

Taken from DTU 59.4: Substrates must be free of water stains, mould and marks (marker lines, ink or pencil lines, graffiti, etc.). Evenness and vertical trueness of walls must comply with applicable local standards.

Extract from Technical Notice:

- slope of at least 1% in the area exposed to water; the slope must be created at least in the shower area delimited by the vertical wall(s) and in the entire area that is not splash-protected and therefore exposed to water; in other words at least 1.80 m from the hose attachment and from the centre line of the drain; given the limited surface area of showers, the slope is generally over the entire surface;
- threshold with chamfered or rounded edges of between 1 and 2 cm opposite the door threshold to prevent water leaving the bathroom when the door is positioned between 1.20 m and 1.80 m from the drain or from the shower hose attachment;
- furthermore, the door must not be situated less than 1.20 m from the shower head attachment point. In cases where water splashes are contained in a surface area delimited by rigid walls, fixed or moveable, the following design requirements are to be applied:
- the wall height must be at least 1.80 m;
- if this surface area is delimited by an threshold of 1 to 2 cm, the slope and watertight sealing are then executed only on this surface area.

4.2. ABOUT THE DRAIN

On water-bound substrate: the plumber should supply and install the drain (at finished slab level at least 30 cm from walls from the centre line of the drain) in coordination with building and flooring contractors.

On timber substrate: the plumber should supply and install the drain (at wood panel level at least 30 cm from walls from the centre line of the drain: fit and tighten the frame and then tighten the drain on the frame) in coordination with the woodwork / timber framing and flooring contractors.

4.3. ABOUT PIPEWORK

4.3.1 - Floor

The following solutions are envisaged:

- Position inside the partition wall
- Pass through a common utility conduit
- Pass through an adjacent room
- Locate together in a corner +

4.3.2 - Wall

Taken from DTU 59.4: The substrates must be free of water stains, mould and inscriptions (chalk lines, ink or pencil lines, graffiti, etc.). Supply and waste pipes for future connection must extend by no more than 5 cm, and the space between pipework and wall should be 5 cm (for installation of MURAL CALYPSO).

4.4. ABOUT SANITARY WARE

- Wall mounting of sanitary ware: wash basin, etc.
- Wall mounting advised: WC
- Horizontal waste outlet mandatory
- Sanitary ware should not be already mounted (technical contractors must arrange for removal and replacement)

[404_{v5}] Shower System

5. FLOOR DRAIN

Installing the drain

The drain is supplied and fitted by the plumber at finished concrete slab level at least 30 cm from walls from the centre line of the drain.

5.1. FLOOR DRAINS AVAILABLE FROM GERFLOR

Drain DUSCHBRUNN (vertical outlet) or FREJA (horizontal outlet) are available from GERFLOR.
Outlet diameter: Ø 50 mm

According to pipework's positioning, drain extension from 35 mm to 107 mm (Ø90D) may be necessary. The drain extension needs to be cut to the expected length; then, clip it in the drain after joint's lubrication with silicone.

It is possible to replace the usual PVC grate by a stainless steel grate (Ø90C).

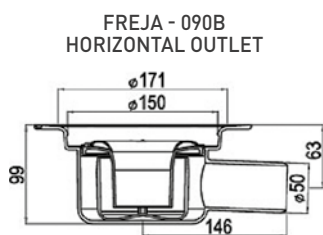
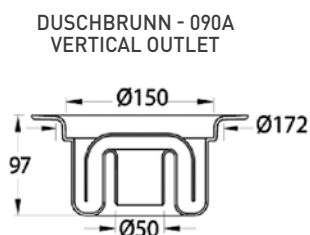

CLAMPING RING
Ø 150 MM- 090I



MINIMAX COMPACT DRAIN - 090G
Grate diameter : Ø 130 mm
Outlet diameter : Ø 50 mm
CLAMPING RING Ø 130 MM - 090H

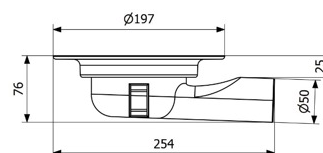

NB: Tightening of the floor in the drain is insured with the **clamping ring provided with the drain**.
The clamping ring can be ordered alone in case of breakage of original's one.

HORIZONTAL DESIGN DRAIN
(600 mm - 090J / 900 mm - 090K)
Outlet diameter : Ø 50 mm

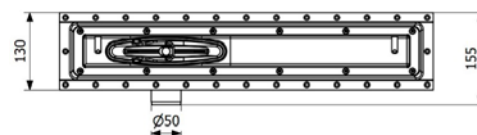
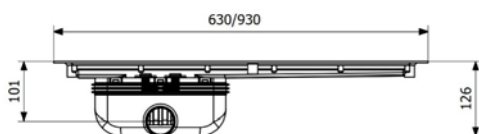

HORIZONTAL COMPACT DESIGN DRAIN
(600 mm - 090L / 900 mm - 090M)
Outlet diameter : Ø 50 mm

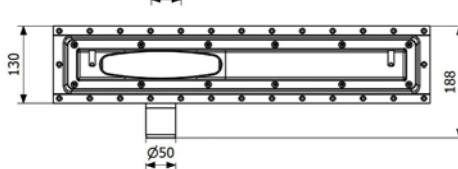
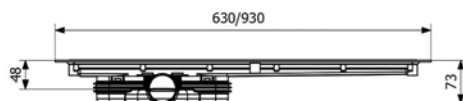

VERTICAL DESIGN DRAIN
(600 mm - 090N / 900 mm - 090O)
Outlet diameter : Ø 75 mm

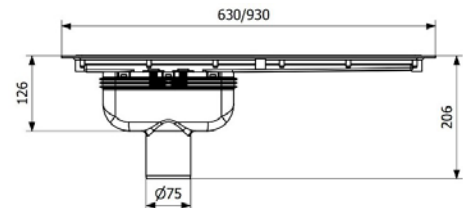

Design drain is available in size 600 mm and size 900 mm and has 3 grates colours: stainless steel, black, and gold.

	STAINLESS STEEL	BLACK	GOLD
600 mm	090P	090R0001	090R0002
900 mm	090Q	090S0001	090S0002

5.2. OTHERS RECOMMENDED MODELS

PVC DRAINS SITAR AND SITAR V FROM NICOLL

Two outlet diameters: Ø 50 mm - Ø 63 mm
Two types: - horizontal Ø 50 mm
- vertical Ø 50 mm and Ø 63 mm

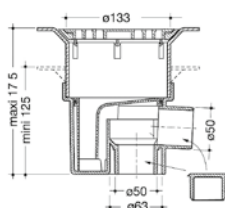

SIPHON SITAR - H112

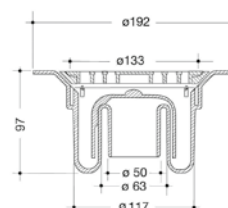

SIPHON SITAR V - H113

[404_{v5}] Shower System

5.3. ON TIMBER SUBSTRATE

For SITAR drains from NICOLL. The drain is supplied and fitted by the plumber on a **reinforcing plate resting** on a header joist in the timber framing at the level of the wood panels at least 30 cm from the walls from the centre line of the drain.
Reinforcing plate resting reference from Nicoll: #TR30SITAR.
Anticipate supply leadtime.

6. PREPARING CORNERS

Cove former (available from GERFLOR)

Ref. : 4011

To be glued onto substrates or on foam in the case of installation on soundproofing layer.

TYPE	COMPANY	NAME
Contact adhesive	UZIN	WK 222
	MAPEI	ULTRABOND ECO CONTACT
	SIKA / CEGECOL	CEGE 100 CONTACT+
Adhesive tape	SIKA / CEGECOL	CEGETACK 25/50/85
	SIKA / PAREXGROUP	940 LANKO CONTACT 25/50/85
	MAPEI	MAPECONTACT PLINTHE
	BOSTIK	BOSTIK ROLL 25/50/85
	HB FULLER	SDB 50/85
	UZIN	REMUR

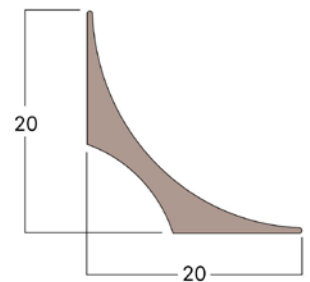

7. INSTALLING THE FLOOR COVERING

7.1. SUBSTRATE

Acceptance of the substrate is carried out in accordance with NF P 62-203-2 (applicable local standards) taking account of the slope of the substrate over the entire area of the premises.

Laying by gluing down the floor covering in lengths is carried out on a substrate implemented in accordance with NF P 62-203-2 (Special Provisions of DTU 53-2: Bonded Plastic Floor Coverings).

7.2. INSTALLATION METHOD

Deployment of a coving system solution for GERFLOR floor coverings.

7.3. INSTALLING THE FLOOR COVERING

7.3.1 - Priming and laying the floor covering

- Minimum ambient installation temperature: 10°C.
- Minimum substrate temperature: 10°C.
- Apply primer before laying the floor covering.

COMPANY	NAME
SIKA / CEGECOL	CEGEPRIM UN2 / CEGEPRIM AN
SIKA	SIKAFLOOR-17 PRIMAIRE ANHYDRITE / SIKAFLOOR-18 PRIMAIRE UNIVERSEL
BOSTIK / MANG	GRIP A700 UNIVERSEL
H.B. FULLER	TEC 049
THOMSIT	R 766
MAPEI	PRIMER G
SIKA / PAREXGROUP	124 PROLI PRIM / 165 PROLI PRIM UNIVERSEL
UZIN	PE 360

7.3.2 - Layout - Preparation of lengths

- Lay the lengths out edge to edge so that welds are more than 20 cm from the drain.
- It is advisable not to have any welds in the shower area.

7.3.3 - Gluing*

- Gluing takes place 24 hours after the lengths are positioned in place.
- The flooring is installed simply by gluing down using acrylic emulsion adhesive applied with a finely-serrated spatula with a coverage of about 300/350 g/m², type A2 (as per TKB specification). The spatula will need to be changed regularly to maintain this coverage.

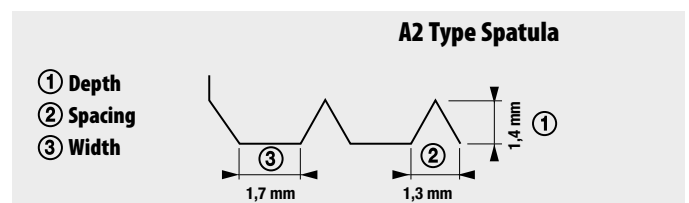

* Recommendations for gluing:

- Carefully follow the instructions provided by the adhesive supplier.
- Ensure compliance with the waiting time which depends on the temperature, the atmospheric conditions of the room, the substrate's porosity and the coverage of the adhesive used.
- If flooring is applied to adhesive having allowed inadequate waiting time then blisters will form.
- If flooring is laid onto adhesive whose working time is exceeded, there will be poor transfer of adhesive to the back of the material (poor adhesion).

COMPANY	NAME
SIKA / CEGECOL	CEGE 100 TECHNIC / CEGE 100 HQT
SIKA	SIKABOND 135 PVC FLOOR / SIKABOND 150 PREMIUM FLOOR
BOSTIK / MANG	POLYMANG SM / TECHNIMANG / PLASTIMANG
BOSTIK / SADER	SADERTAC V6 / SADERTECH V8 / SADERFIX T3
BOSTIK / MIPLACOL	STIX A800 PREMIUM / STIX A300 MULTI FLOOR / STIX A200 MULTI VINYL
H.B. FULLER	TEC 522 / TEC 540
THOMSIT	THOMSIT K 188 E
MAPEI	ULTRA BOND ECO 370 / ULTRA BOND ECO V4 SP
SIKA / PAREXGROUP	915 LANKOCRYL PLUS / 932 LANKOCRYL MAX
UZIN	KE 2000 S

7.3.4 - Laying the lengths

- Fold back half the length. Glue the substrate and apply the flooring.
- Fold back the other half and proceed in the same way, leaving play of 1 mm.
- Do not overlap two adhesive films when you apply more adhesive.

[404_{v5}] Shower System

7.3.5 - Smoothing

- Careful manual smoothing during laying to ensure correct transfer of the adhesive film.

Important

- Foot traffic 24 hours after laying.
- Do not install fittings or furniture until 48 hours after laying.
- Do not use furniture items with rubber feet.

7.3.6 - Water-tightness of floor covering/drain join

ADVICE FOR EASIER INSTALLATION

1 Unroll and glue the GERFLOR floor covering up to the screw plate. Double acrylic gluing around the drain is recommended. Lay the lengths out edge to edge so that welds are more than 50 cm from the edge of the drain.

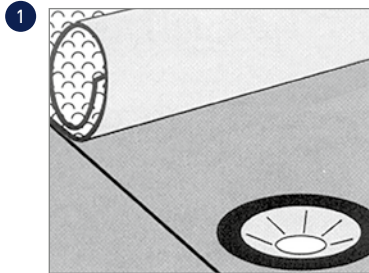

2 Draw the cutting circle inside the flange positioned above the hole.

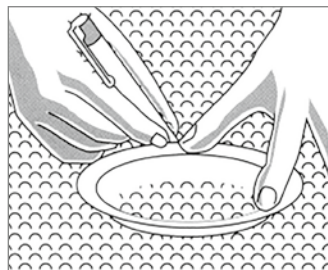

3 Cut the floor covering.

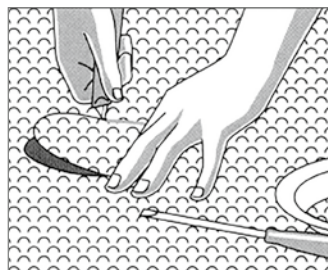

4 Heat the material using a hot air tool.

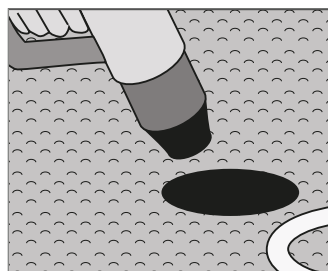

5 Position the flange on top. Fix it according to its model: with clamping ring or with screws.



For DUSCHBRUNN and FREJA drains, it is possible to place the knife's support (Ref. : 090E) during floor covering laying.

For MINIMAX COMPACT drain, knife to use is reference 090F.

The knife will be placed during step 3 and will insure a perfect cut.

Cutting circle is done by centering the flange on the drain. As such, cutting circle can be drawn considering the inner diameter of the flange. Floor covering will be tightened between flange and gully by assembly.

For DUSCHBRUNN and FREJA drains, if the knife (090E) is not used, the cutting circle must be done with 125 mm diameter.

For MINIMAX COMPACT drain, if the knife (090F) is not used, the cutting circle must be done with 100 mm diameter.

Cutting circle can be done using a hook blade following the drawing done during step 2.

For DUSCHBRUNN, FREJA or COMPACT MINIMAX drains, if the knife is used and that its support wasn't placed during step 1, it is recommended to cut the floor covering according to a cross to place it.

Heating is carefully done to avoid burns and aspect's modification of the floor covering.

Material's relaxation will make easier the tightening of the floor covering when installing the flange or the clamping ring.

For DUSCHBRUNN, FREJA and COMPACT MINIMAX drains, the clamping ring is installed in the same time as the grate by foot's pressure.

[404_{v5}] Shower System

ADVICE FOR EASIER DESIGN DRAIN INSTALLATION :

Specific point : floorin is held flat on the drain by a flat clamping frame.
Installation is the same than round drains.

1- Install the drain.

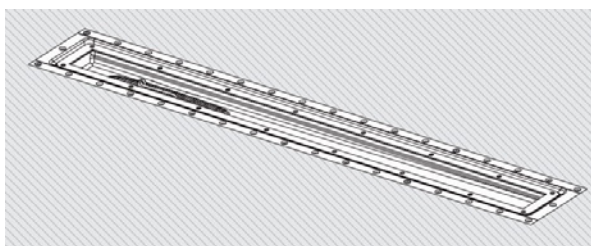

2- Glue the flooring on the substrate and the drain without the clamping frame ; use the clamping frame to define the flooring part to cut.

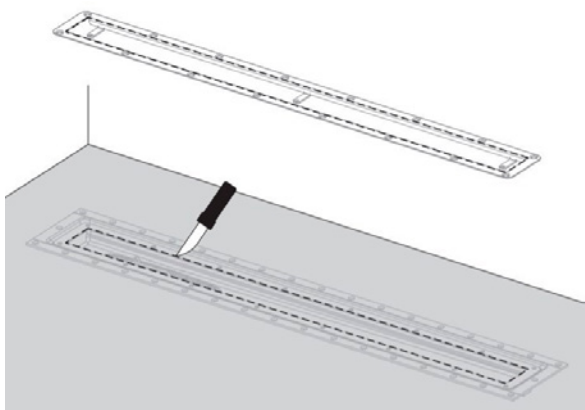

3- Heat the material to make easier the tightening of the flooring when installing the clamping frame.

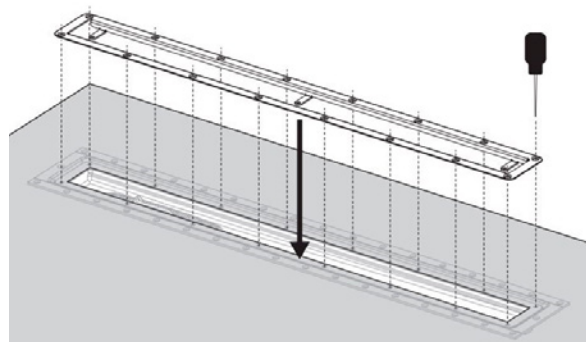
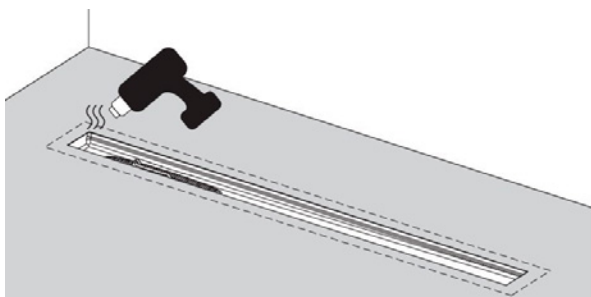

4- Place and screw the clamping frame.

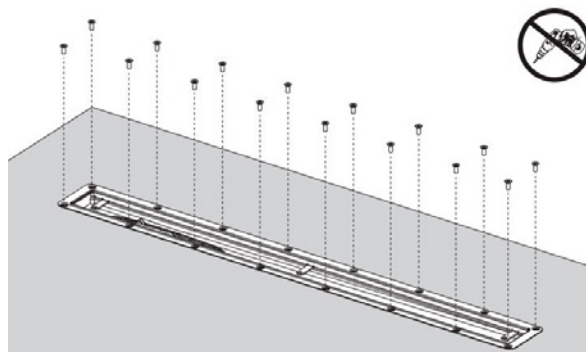

5- Place and screw the grate on the clamping frame.

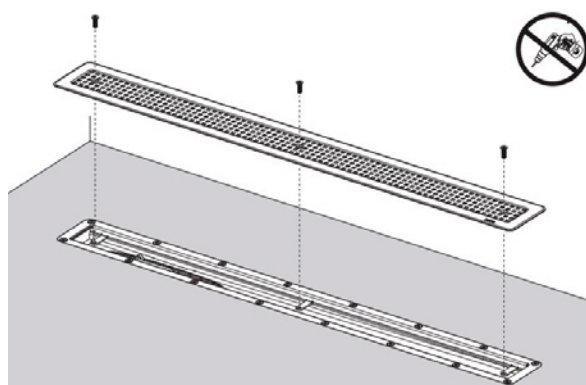

[404_{v5}] Shower System

7.4. WATERTIGHT SEALING AT EDGES IN CORNER BY COVING SYSTEM

Usual rule is a coving system of 13 cm. When wall-mounted WC and wall's reinforcement solution (refer §8.5) are positioned to the junction of the wall covering and the coving system, coving system need to be placed under this junction.

As such, coving system needs to be at least 10 cm.

INTERNAL CORNER

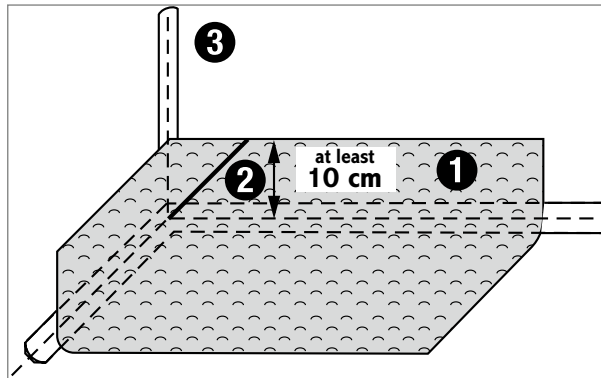

- 1 Glue the floor covering on the wall up to 13 cm.
- 2 Cut the floor covering at 45° and weld using CR 40 rod.
- 3 WALL corner: fix by double gluing the CA 12 corner bead over the full height from the coving system.

EXTERNAL CORNER

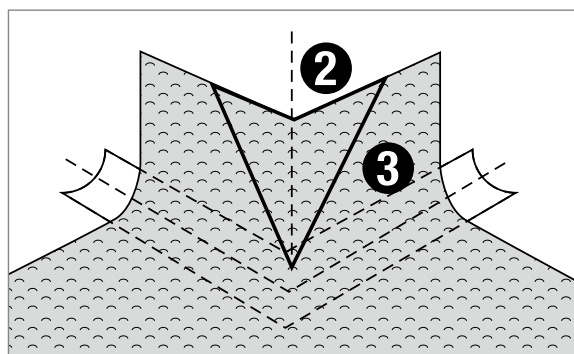
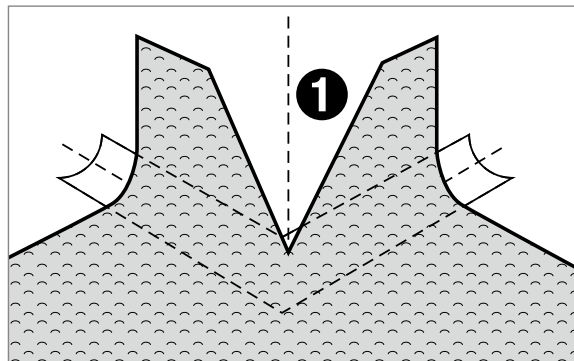

- 1 Cut the floor covering up to the mid-height of the cove former.
- 2 Add a piece of floor covering.
- 3 Weld with CR 40 weld rod and trim.

Gluing of coved corners can be done using translucent PU contact adhesive by HB Fuller TEC 222 or a water based contact adhesive or double-sided adhesive tape. GERFLOR recommends that you refer to the technical data sheets for the adhesives or adhesive tapes for instructions on their use.

[404_{v5}] Shower System

7.5. TREATMENT OF JOINTS

No welding on the drain

- Heat welding is mandatory (at least 24 h after gluing).

Chamfering

Chamfering allows the joint to be opened and adjusted, to remove any traces of adhesive that may impair the quality of the weld:



Triangular scraper, Ref.: 95185 by ROMUS



Linéa, Ref.: 95101 by ROMUS



Master Turbo, Ref.: 95200 by ROMUS



Swift groover Ref.: 262 611 400 by JANSER

- It is executed using an appropriate tool.

- Chamfering should be executed over the thickness of the floor covering minus about 0.3 mm.

Welding of GERFLOR floor coverings with CR40 weld rod

Welding is with a LEISTER type adjustable hot air gun with suitable speed nozzle. It is also possible to weld with the speed welding nozzle (Ø 5 mm). For all types of welding equipment, follow the manufacturer's instructions

Trimming of GERFLOR floor coverings

This operation should be done after the weld seam has cooled with:

- either a trimming tool,
- or a flexible spatula sharpened in the middle,

IMPORTANT!

GERFLOR is at your disposal for any further information on equipment.

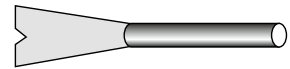

7.6. SHOWER / BEDROOM JOIN (Réf. : 0469)

7.6.1 - Join with a PVC shower threshold

Packaging (0469): 8 x 3 ml

Installation: Gluing of shower thresholds can be done using translucent PU contact adhesive by HB Fuller TEC 222 or a water based contact adhesive or double-sided adhesive tape.

GERFLOR recommends that you refer to the technical data sheets for the glues or adhesives for instructions on their use.

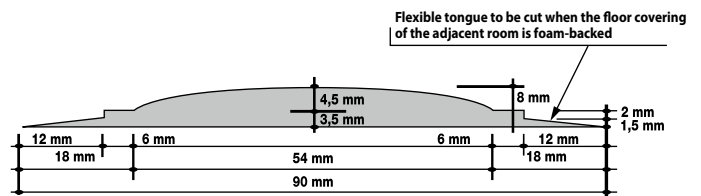

7.6.2 - For a join with another rubber or linoleum floor covering

Sealing with a MS POLYMER sealant, on shower and bedroom side.

7.6.3 - For a join with a rubber shower threshold

Sealing with a MS POLYMER sealant, on shower and bedroom side. Sealing should also be done around bottom of door frames.

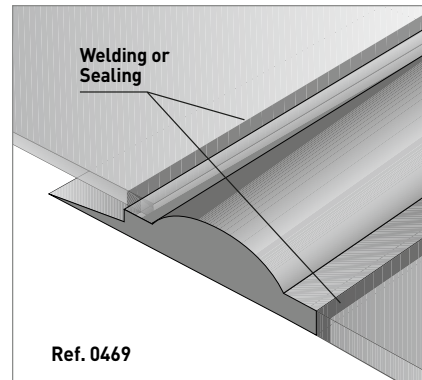
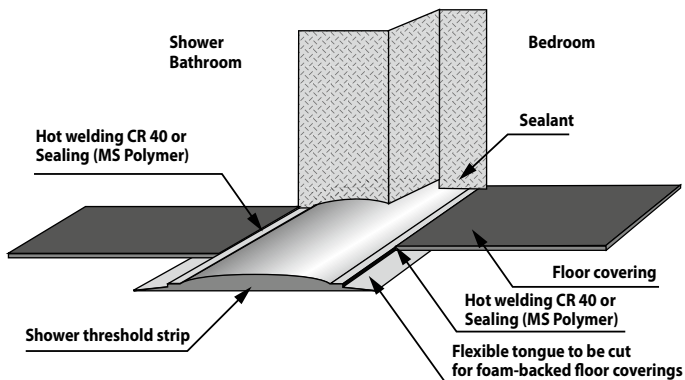

8. INSTALLING THE WALL COVERING: MURAL CALYPSO

8.1. SUBSTRATE

Installation by gluing of the wall covering in lengths is carried out on a substrate implemented in accordance with:

- Applicable local standards
- The Technical Notice for the substrates concerned
- The GERFLOR installation guide "Preparation of substrates for wall coverings"

Recap of Requirements:

The substrates must be free of water stains, mould and inscriptions (chalk lines, ink or pencil lines, graffiti, etc.).

- After light sanding and dust removal, the coating must not show any chalking, chapping, cracks, holes or streaks greater than or equivalent to 1 mm.
- Local evenness: 1 mm under 20 cm straight-edge.
- Overall evenness: 5 mm under 2.00 m straight-edge.
- Vertical trueness: 5 mm under 2.50 m straight-edge.
- Mean hardness: 45 shore C.
- Moisture content less than 5% by weight.

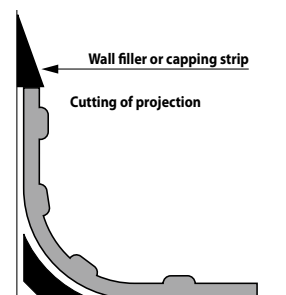

[404_{v5}] Shower System

8.2 - PREPARING THE CONNECTION ON THE COVING SYSTEM

Projections under the overlap will be cut using a trimming plane or quarter moon cutter. The difference in thickness is made up for by feathering with filler or by a capping strip.

INTERNAL CORNER: 1

Glue a CA12 corner bead in the corner before installing the MURAL CALYPSO wall covering.

EXTERNAL AND OBTUSE CORNER > 90°: 2-3

For external and obtuse corners >90°, double gluing with water based contact adhesive is needed to prevent loss of adherence over time. Use of double-sided adhesive tape is possible if the tape's manufacturer is in agreement and guarantees it for this use.

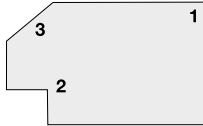

8.3 - INSTALLING MURAL CALYPSO ON FULL HEIGHT

The lengths can be laid vertically or horizontally. If there is a false ceiling, install MURAL CALYPSO before fitting corner protection. Sealing may be required on the layer of material above the false ceiling.

For horizontal laying the material should be unrolled to reach a height of 1.95 m from the top of the coving keeping at least 3 cm overlap with the floor covering. Then add a strip starting from the ceiling or false ceiling creating an overlap of 3 cm.

8.3.1 - Installation and storage temperature

- For vertical and horizontal laying, cut the lengths at least the day before.
- Minimum substrate temperature: 10°C
- Minimum ambient installation temperature: 15°C.
- Store the wall covering at the minimum installation temperature (15°C) for 24 hours.

8.3.2 - Marking guidelines

Vertical laying:

Draw an initial plumb line positioned according to the dimensions of the room so as to avoid any welding close to (within >10 cm) or at a corner.

Horizontal laying:

Draw a line at 1.95 m from the coving all around the edges of the bathroom.

8.3.3 - Gluing

Application as a single coat of water based dispersion adhesive (acrylic) with a type A4 finely serrated spatula (as per TKB recommendation) and crossed with a medium length pile roller or applied directly with the medium length pile roller.

* Recommendations for gluing

- Carefully follow the instructions provided by the adhesive supplier.
- Carefully respect the waiting time which depends on the temperature, the atmospheric conditions of the room, the substrate's porosity and the coverage of the adhesive used.

Primers for wall:

COMPANY	NAME
SIKA / CEGECOL	CEGEPRIM UN2 / CEGEPRIM AN
SIKA	SIKAFLOOR-17 PRIMAIRE ANHYDRITE / SIKAFLOOR-18 PRIMAIRE UNIVERSEL
BOSTIK / MANG	GRIP A700 UNIVERSEL
H.B. FULLER	TEC 049
THOMSIT	R 766
MAPEI	PRIMER G
SIKA / PAREXGROUP	124 PROLIPRIM / 165 PROLIPRIM UNIVERSEL
PRB	PRB ACCROSOL AG / PRB ACCROSOL EXPRESS
UZIN	PE 360

Adhesives for wall :

COMPANY	NAME
SIKA / CEGECOL	CEGE 100 TECHNIC / CEGE 100 HQT
SIKA	SIKABOND 135 PVC FLOOR / SIKABOND 150 PREMIUM FLOOR
BOSTIK / MANG	POLYMANG SM / TECHNIMANG / PLASTIMANG
BOSTIK / SADER	SADERTAC V6 / SADERTECH V8 / SADERFIX T3
BOSTIK / MIPLACOL	STIX A800 PREMIUM / STIX A300 MULTI FLOOR / STIX A200 MULTI VINYL
H.B. FULLER	TEC 522 / TEC 540
THOMSIT	THOMSIT K 188 E
MAPEI	ULTRA BOND ECO 370 / ULTRA BOND ECO V4 SP
SIKA / PAREXGROUP	915 LANKOCRYL PLUS / 932 LANKOCRYL MAX
PRB	FIXOSUP / FIXOTEC
UZIN	KE 2000 S / KE 28

8.3.4 - Applying adhesive to the substrate and laying the lengths

8.3.4.1 - Gluing for vertical installation

Glue over the entire height up to the ceiling

8.3.4.2 - Gluing for horizontal installation

Glue only up to the specified height for application of the length.

Gluing of the strip will be done only after installation of the horizontal length.

8.3.4.3 - Gluing of corners

INTERNAL CORNER: 1

Glue CA12 corner bead with acrylic adhesive in the corner before installing the MURAL CALYPSO wall covering.

EXTERNAL AND OBTUSE CORNER > 90°: 2-3

For external and obtuse corners >90°, double gluing with water based contact adhesive is needed to prevent loss of adherence over time. Use of double-sided adhesive tape is possible if the tape's manufacturer is in agreement and guarantees it for this use.

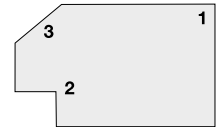

8.3.5 - Laying the lengths

Leave a gap between 1 mm and 1,5 mm between rolls to make easier the grooving with triangular scraper.

8.3.5.1 - Vertical installation

Cut the length the day before allowing a margin (at least 10 cm). Lay the lengths avoiding any welds in the shower area.

8.3.5.2 - Horizontal installation

8.3.5.2.1 - Laying a length

Cut the length the day before allowing a margin (at least 10 cm). Draw a horizontal guide line at 1.95 m from the top of the coving all around the edges of the room. Draw a vertical marker line on the entire height of the wall opposite the door. On the top edge of the material make a mark corresponding to the middle of the length before rolling it in on both sides. Unroll one of the rolled-in sides following the horizontal guide line smoothing it as you work. Proceed in the same way for the second side.

8.3.5.2.2 - Laying the upper strip:

Cut the strip the day before allowing a margin both lengthwise and width-wise. Draw a horizontal guide line 3 cm below the edge of the laid length so as to obtain an even overlap. Place protective paper underneath this horizontal guide line to prevent traces of adhesive on the length already laid. Glue the upper part and also the 3 cm overlap. Unroll the strip proceeding in the same way as for the length and making the weld above the door.

8.3.6 - Smoothing

a) During fixing

Remove air pockets from top to bottom and from centre to edges using a cork pressing block.

For external corners:

- Smooth up to the corner.
- Wrap the wall covering around while smoothing out the corner and finish with the external corner roller.

For internal and obtuse corners:

Bring the wall covering to the corner smoothing it with the internal corner roller.

b) Final smoothing

Using a cork pressing block smooth the entire surface. In order to prevent a stretched effect at internal corners we do not recommend heating the material.

8.3.7 - Trimming

Trim the material along the ceiling or false-ceiling.

We recommend sealing after trimming with a MS Polymer sealant.

[404_{v5}] Shower System

8.3.8 - Treatment of joints (24 hours after gluing)

LAYING THE LENGTHS	MURAL CALYPSO. SPACING BETWEEN LENGTHS: 1 MM + 0.5 - 0 MM	
	Tools	Use
Chamfering	Ensure that joints are even. Remove traces of adhesive which may prevent fusion of the weld rod.	
	Triangular scraper	The shallow thickness of the material means that each edge needs to be chamfered separately using a triangular scraper tilted right and then left. This method increases the contact area of the CR 40 rod when welding.
Welding	HOT JET S type fitted with a RAPID ULTRA nozzle	CR 40 weld rod. Airflow output: position 4 (80 l air / min) / Temperature: 450° to 500°, position between 4 and 5.
	LEISTER TRIAC fitted with a VENTED nozzle	Airflow output: 230 l/min. Temperature: position between 4 and 5. The vented nozzle should be cleaned after each weld.
Levelling/trimming	SLIM or MOZART levelling spatula Quarter moon cutter + levelling guide	Use a levelling spatula sharpened only in the middle so as not to cut into the material.

8.4. OVERLAPPING THE COVING (OR EDGING)

The wall covering overlaps the coving of the floor covering by 3 cm. MURAL CALYPSO is glued to the coving with acrylic adhesive or adhesive tape (ref §6).

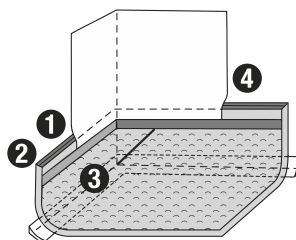

- 1 The difference in thickness is made up for by feathering with wall filler or a capping strip
- 2 Remove projections with a 1/4 moon cutter over 3 cm.
- 3 The floor covering under the overlap should be protected with masking tape.
- 4 Apply the adhesive. Remove the masking tape before applying the MURAL CALYPSO. Heat and smooth MURAL CALYPSO on the overlap using a flat roller.

8.5. WALL-MOUNTED WC

- This type of fitting should be installed in accordance with the bathroom fitting and frame-substrate standard XP D 12-208.
- WC bowls should be fixed onto two BA 13 panels glued together or on BA 25 or on BA 18 extra hard.

NOTE: Gluing and cutting of MURAL CALYPSO around WC fittings must be done with great care and comply with our recommendations.

Reminder: A4 spatula, coverage: approx. : 150/200 g/m², crossed with a medium length pile roller, final smoothing with heat gun and cork pressing block.

In the case of a wall-hung WC, and in the absence of any specific reinforcement, there is a potential risk of blistering on the wall covering at the join of the WC with the plasterboard substrate owing to tightening of the fixings and risk of gradual bending of the substrate; insertion of a rigid sheet of the contractor's choice is one solution for improving wall rigidity and may reduce this risk.

For all other cases, please consult us: Tel.: +33 (0)4 74 05 40 08 / + 33 (0)4 74 05 45 78

8.6. FINISHING - CONNECTION WITH UTILITIES / SERVICES INFRASTRUCTURE

Gluing, cutting and finishing of MURAL CALYPSO around utilities/services infrastructure must be executed with particular care and comply with our recommendations.

8.6.1 - Wall fittings

Sealing of wall fittings should be included in the plumbing work on installation of wash basins, bathroom cabinets, wall mounted cisterns, grab handles, inspection hatches, etc.

Sealing - Ref.: BOSTIK MS 107

8.6.2 - Services through walls (heating, plumbing)

Sealing of services through walls should be included in the plumbing work. HW/CW inlet: shower, wash basin - Soil pipes: grey water / black water

Sealing - Ref.: BOSTIK MS 107

8.6.3 - Bathroom edges

Bottom of door frames - window - around false ceiling edges (when MURAL CALYPSO is fitted afterwards).

Sealing - Ref.: BOSTIK MS 107

Door threshold:

heat welding with plastic floor covering of adjacent room or on shower threshold strip (bedroom, corridor) see 6.6.

8.6.4 - Electricity

Switch - Socket

Cf. standard NFC 15-100 (amendment May 1991). Minimum distance (in France) between an electric point and a fixed shower head or shower hose attachment: 1.20 m.

8.6.5 - Ventilation

Natural: low inlet / high inlet

Mechanical: wall/ ceiling outlet

Sealing - Ref.: BOSTIK MS 107

8.6.6 - Special cases - Renovation

(See 3.3.1 Floor)

Horizontal and vertical pipe runs - Fixing of bathroom fittings.

Location of pipes together in a corner and full height boxing in.

Special case: Horizontal sealing around pipes in renovation works.

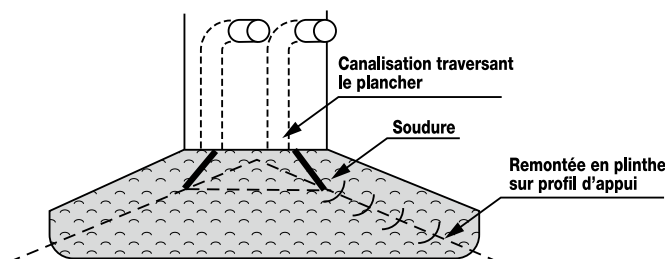

The MS POLYMER sealing solution may be acceptable in certain renovation cases around hot and cold water inlets and wash basin waste pipes, heating pipes, vertical WC outlets on condition that they are outside the shower's water splash range.

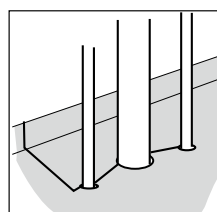

CUTTING OF MATERIAL AROUND PIPES AND WELDING

[404_{v5}] Shower System

9. APPENDIX - SHOWER SYSTEM COMFORT PLUS ONLY FOR INSTALLATION OF TARASAFE UTRA H₂O AND ELEGANCE SD

■ 9.1. FITTING SOUNDPROOF UNDERLAY

- The TARAFOAM underlay is installed at least 24 hours before the shower floor covering.
- Lay the foam flat with the reinforced surface that will be in contact with the floor covering uppermost.
- The foam is laid edge to edge
- The foam is glued with a water based contact dispersion adhesive (acrylic) applied with a TKB standard A2 spatula
- Cut and trim around edges
- Cut around the drain, allowing about 1 cm
- Glue the cove former to the TARAFOAM underlay

■ 9.2. INSTALLING THE FLOOR COVERING

Glue the floor covering onto the underlay using a compact/compact acrylic adhesive at 200 to 250 g/m² with type A5 spatula (TKB specification), then flatten ridges in the adhesive with a medium length pile roller. (The waiting time MUST be complied with for this type of gluing). Install the floor covering following the same principle as over.

10. LIST OF SPECIAL TOOLS

ROMUS

ZA des Pouards 13 et 15 rue du Taillefer
B.P. 291 - 91162 LONGJUMEAU CEDEX
Tel.: 01 69 79 69 79 - Fax: 01 64 48 41 00
e-mail: commercial@romus.fr

JANSER S.A.

Parc d'activités de la Mossig
B.P. 18 - 67521 MARLENHEIM CEDEX
Tel.: 03 88 59 28 20
Fax: 03 88 59 28 22

WOLFF

4, avenue du Président Coty
02880 CROUY
Tel.: 03 23 76 37 52
Fax: 03 23 76 37 51

	ROMUS	JANSER	WOLFF
WALL SCRIBER - max. height à 200 mm	Ref.: 95430	Ref.: 222 430 100	
GLUING SPATULA with interchangeable blade (18 cm)			
A 2 BLADE TKB Standard		See catalogue	
A 4 BLADE TKB Standard			
PRESSURE ROLLER - steel ø 30 x 45 mm		Ref. : 224 400 125	Ref. : 111 200 000
COVING RULER - For cutting floor coverings at 13 cm and 10 cm from floor, at coving height		Ref. : 224 432 000	
CORK PRESSING BLOCK FOR SMOOTHING	Ref.: 93145	Ref.: 262 380 000	Ref.: 720 930 000
COMBINED TRACER AND MARKING GAUGE - (spur 1 mm thick)	Ref.: 93355	Ref.: 262 130 500	
SPARE BLADE (in 5s)	Ref.: 93356	Ref.: 262 415 001	
SPARE POINT ø 1,5 mm (in 20s)	Ref.: 93357	Ref.: 262 126 000	
ROLLER FOR INTERNAL CORNERS	Ref.: 093135	Ref.: 224 400 123	Ref.: 116 340 000
ROLLER FOR EXTERNAL CORNERS		Ref.: 262 614 000	Ref.: 116 350 000
TRIMMING TOOL for Coving	Ref.: 95103	Ref.: 262 635 000	
RAPID ULTRA NOZZLE	Ref.: 95027	Ref.: 224 800 007	
BUSE RAPID POUR REMONTÉE EN PLINTHE	Ref.: 95028	Ref.: 224 800 013	
VENTED NOZZLE	Ref.: 95030	Ref.: 224 700 300	
TRIANGULAR SCRAPER	Ref.: 95185		
LINEA GROOVER	Ref.: 95101		
MASTER TURBO	Ref.: 95200		
SWIFT GROOVER		Ref.: 262 611 400	
TRIMMING SPATULA - For trimming floor coverings with projections		Ref.: 262 609 100	Ref.: 116 400 000 Ref.: 116 402 000
PRESSURE BALL - Brass - ø 13 mm - For rounding joints in corners		Ref.: 224 816 000	Ref.: 116 200 000
ROUND FILE ø 4 mm - For sharpening trimming spatulas and cleaning vented nozzles	Ref.: 95191	Ref.: 262 609 102	

[404_{v5}] Shower System

11. ACCESSORIES

11.1. ACCESSORIES AVAILABLE FROM GERFLOR

Accessories for flooring and wall :

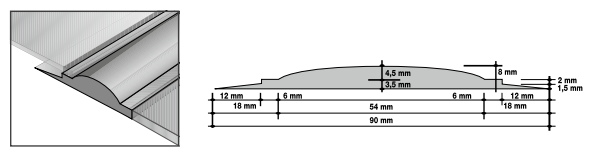

Shower threshold (0469)

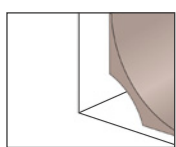

Cove former (4011)

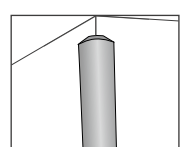
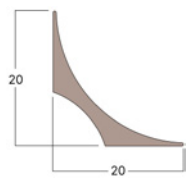

Corner bead CA12 (H204)

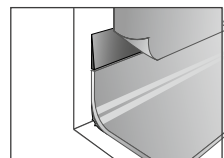
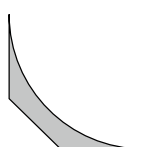

Capping strip (0490)

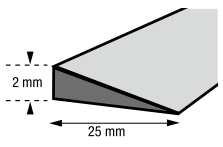

Drains and accessories :

- Drains Ø 150 mm diameter

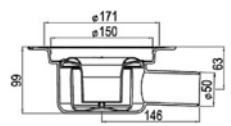

Freja drain - horizontal outlet (090B)

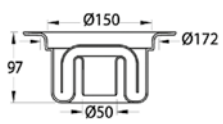

Duschbrunn drain - vertical outlet (090A)



Clamping ring Ø 150 mm (090I)
if breakage of original's one (renovation)



Knife for drain Ø 150 mm (090E)



Stainless steel grate (090C)
if change of plastic grate



Drain extension (090D)

Drains and accessories :

- Drain Ø 130 mm diameter

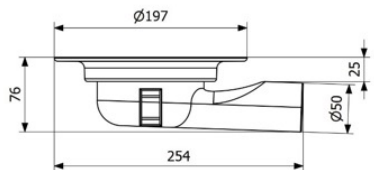

Minimax Compact Drain (090G)



Clamping ring Ø 130 mm (090H)
if breakage of original's one (renovation)



Knife for drain Ø 130 mm (090F)

[404_{v5}] Shower System

Drains and accessories :
 • Design drains

HORIZONTAL DESIGN DRAIN
 (600 mm – 090J / 900 mm – 090K)
 Outlet diameter : Ø 50 mm

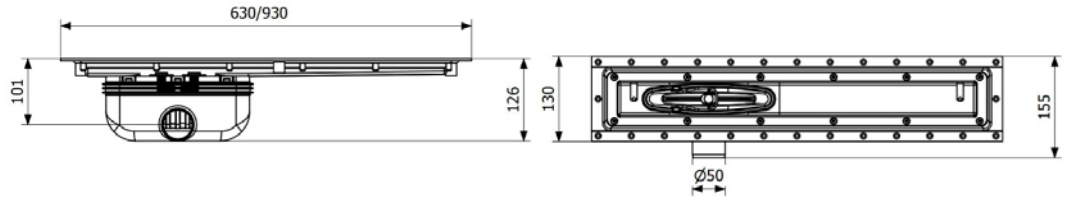

HORIZONTAL COMPACT DESIGN DRAIN
 (600 mm – 090L / 900 mm – 090M)
 Outlet diameter : Ø 50 mm

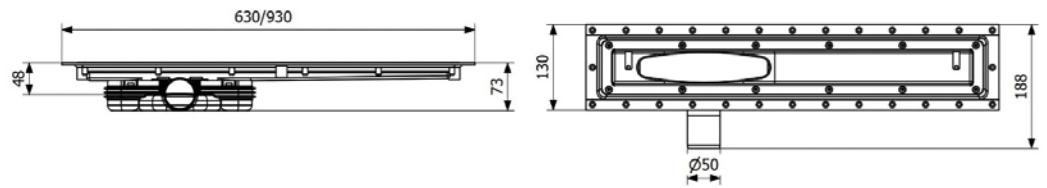

VERTICAL DESIGN DRAIN
 (600 mm – 090N / 900 mm – 090O)
 Outlet diameter : Ø 75 mm

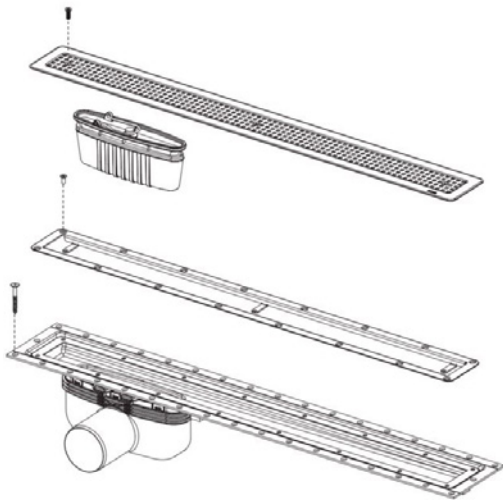
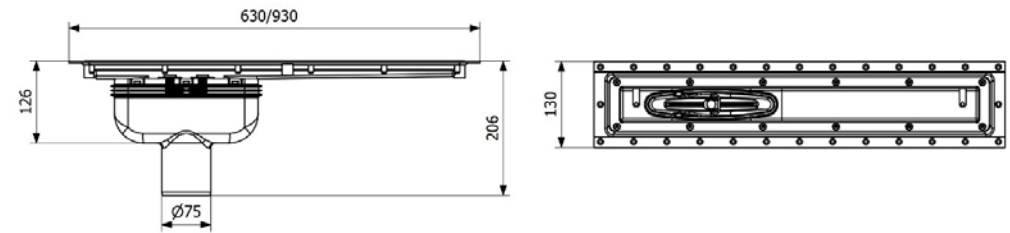

Design drain is available in size 600 mm and size 900 mm and has 3 grates colours: stainless steel, black, and gold.

	STAINLESS STEEL	BLACK	GOLD
600 mm	090P	090R0001	090R0002
900 mm	090Q	090S0001	090S0002

11.2. OTHER RECOMMENDED ACCESSORIES, BUT NOT AVAILABLE FROM GERFLOR

SEALANT - BOSTIK SA - Tel.: + 33 (0)1 64 42 12 12 -
 Ref.: POLYMER MS107 by BOSTIK